

## BL 12-26A



### ► Specifications

Nominal Voltage		12V
Rated capacity (20 hour rate)		26Ah
Dimensions	Length	175± 1.5mm (6.89inch)
	Width	166± 1mm(6.54inch)
	Height	125± 1mm(4.92inch)
	Total Height	125± 1mm(4.92inch)
Approx. Weight		7.5kg(16.53lbs)± 4%

### ► Outer Dimensions (mm)

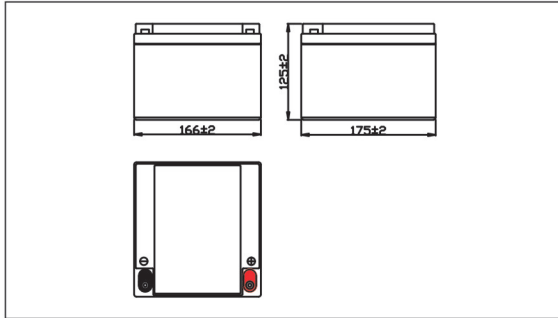

### ► Terminal Type (mm)

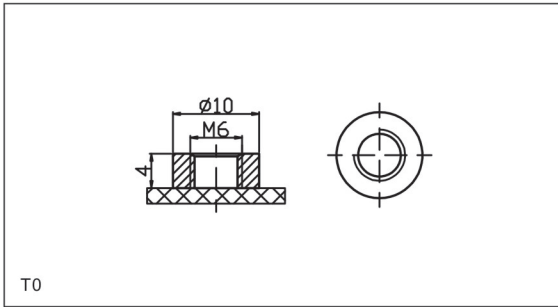

### ► Characteristics

Capacity (25°C)	20HR(10.5V)	26Ah
	10HR(10.5V)	24Ah
	1HR(9.60V)	14.8Ah
Terminal type		T0
Internal resistance (Fully charged,25°C)		Approx.12.5m Ω
Capacity affected by temperature (20HR)	40°C	102%
	25°C	100%
	0°C	85%
	-15°C	65%
Self-discharge (25°C)	3 months	Remaining Capacity:91%
	6 months	Remaining Capacity:82%
	12 months	Remaining Capacity:65%
Nominal operating temperature		25°C± 3°C(77°F ± 5°F)
Operating temperature range	Discharge	-15°C~50°C(5°F~122°F)
	Charge	-10°C~50°C(14°F~122°F)
	Storage	-20°C~50°C(-4°F~122°F)
Float charging voltage(25°C)		13.50 to 13.80V Temperature compensation: -18mV/°C
Cyclic charging voltage(25°C)		14.50 to 15.00V Temperature compensation: -30mV/°C
Maximum charging current		7.2A
Maximum discharge current		330A(5 sec.)
Designed floating life(20°C)		10 years

### ► Construction

Component	Positive plate	Negative plate	Container	Cover	Separator	Electrolyte	Safety valve	Terminal
Raw material	Lead dioxide	Lead	ABS	ABS	AGM	Sulfuric acid	Rubber	Copper

### ► Constant Current Discharge Characteristics Unit: A (25°C, 77°F)

F.V/Time	5min	10min	15min	30min	1HR	2HR	3HR	5HR	8HR	10HR	20HR
9.60V	81.3	50.1	41.2	25.6	14.8	8.5	6.3	4.3	2.8	2.45	1.32
9.90V	77.5	48.6	40.2	24.7	14.4	8.5	6.3	4.3	2.8	2.43	1.31
10.2V	75.6	47.6	39.5	24.3	14.2	8.4	6.2	4.2	2.7	2.41	1.31
10.5V	71.8	46.2	38.5	22.8	13.9	8.4	6.1	4.1	2.6	2.40	1.30
10.8V	69.3	44.7	37.5	21.6	13.5	8.3	6.0	4.1	2.6	2.34	1.24

### ► Constant Power Discharge Characteristics Unit: W (25°C, 77°F)

F.V/Time	5min	10min	15min	30min	1HR	2HR	3HR	5HR	8HR	10HR	20HR
9.60V	878.0	545.8	453.2	286.7	168.4	98.3	72.9	50.4	33.0	28.9	15.7
9.90V	852.8	539.5	450.2	279.1	164.2	97.8	73.1	50.3	32.6	28.7	15.6
10.2V	831.6	528.3	442.3	274.6	162.0	97.0	71.9	49.4	31.9	28.3	15.6
10.5V	797.0	517.1	435.0	259.9	159.3	97.9	71.4	48.6	30.9	28.0	15.5
10.8V	776.2	505.7	427.6	248.4	155.2	96.6	70.2	48.4	30.9	27.4	14.8

Note: The above characteristics data can be obtained within three charge or discharge cycles.

### ► Discharge Characteristics (25°C)

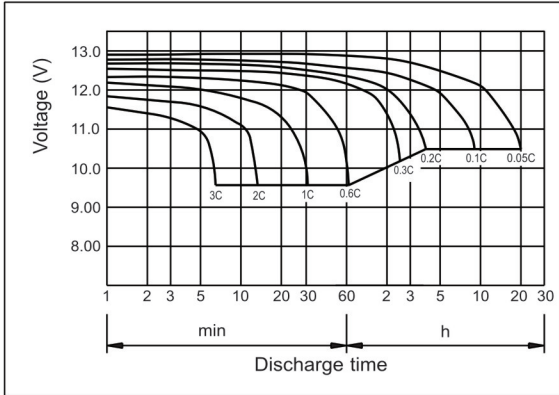

### ► Charging Characteristics (25°C)

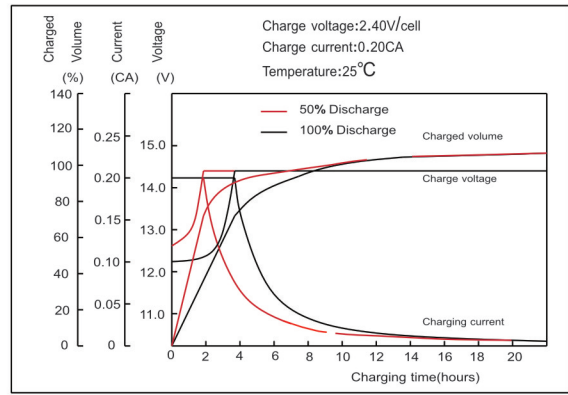

### ► Temperature effects on Capacity

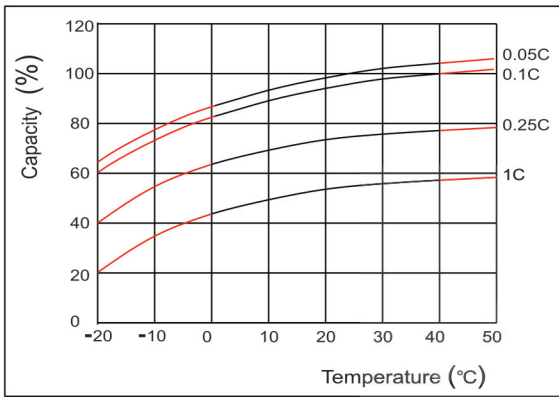

### ► Self-Discharge Characteristics

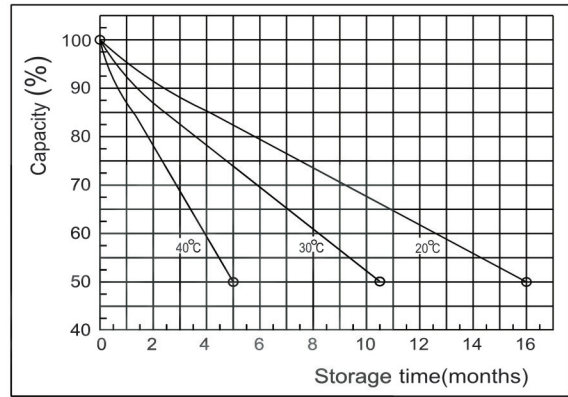

### ► Floating Life on Temperature

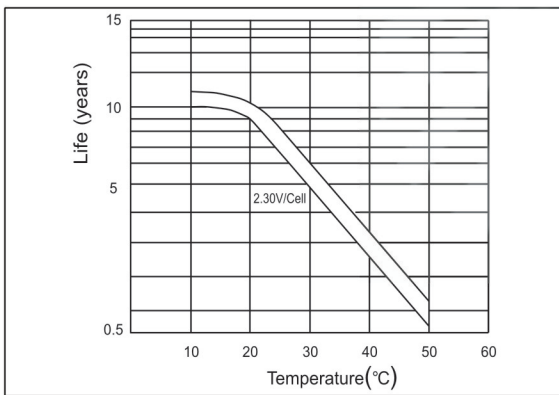

### ► Cycle Life on D.O.D (25°C)

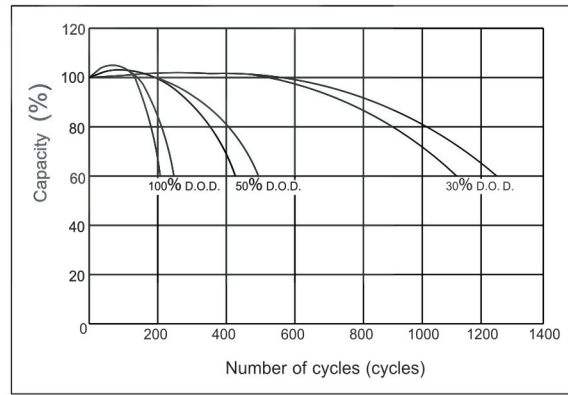

### ► The Relationship for OCV and Capacity (25°C)

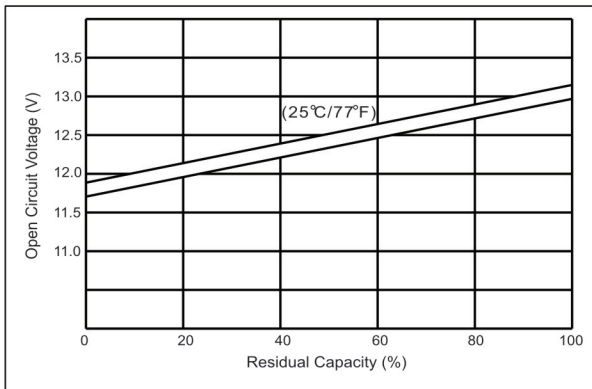

### ► The Relationship for Charging Voltage and Temperature

